

PDS\_515

## STEERING WHEEL 'DIAMOND'



**MANUAL** : M515  
**SALESSTATUS** : STD  
**PRODUCT DIMENSIONS** :

**MATERIAL :**



### EN steering wheel 'Diamond'

- unique KBT design
- injection moulded PP
- light weight design
- includes 3 woodscrews (Ø 4,5 x 60 mm)

### NL stuurwiel 'Diamant'

- uniek KBT ontwerp
- spuitgegoten PP
- licht gewicht ontwerp
- inclusief 3 hout Schroeven (Ø 4,5 x 60 mm)

### FR volant 'Diamant'

- dessin unique de KBT
- PP moulé par injection
- conception légère
- y compris 3 vis (Ø 4,5 x 60 mm)

### DE Lenkrad 'Diamant'

- einzigartiges KBT Design
- PP Spritzguss
- leichtes Design
- inklusive 3 Holzschrauben (Ø 4,5 x 60 mm)







### ES volante 'Diamante'

- diseño KBT exclusivo
- plástico PP inyectado
- diseño ligero
- incluye 3 tornillos (Ø 4,5 x 60 mm)

### PL kierownica 'Diament'

- unikatowy wzór KBT
- polipropylen formowany
- lekka konstrukcja
- zawiera 3 wkręty do drewna (Ø 4,5 x 60 mm)

### PACKAGING

|      |   |   |   |   |
|------|---|---|---|---|
|      |  |  |  |  |
| 515. | 0,35 kg   | 10  | 39 x 39 x 39 cm   | 4 kg  |
|      |  |  |  |   |
| 515. | 18  | 120 x 80 x 130 cm   | 75 kg   |   |



KBT nv  
Hemelrijken 8  
2890 Sint-Amands  
Belgium



KBT Polska sp. z o.o.  
ul. M. Konopnickiej 6  
00-491 Warszawa  
Poland

## STEERING WHEEL 'DIAMOND'

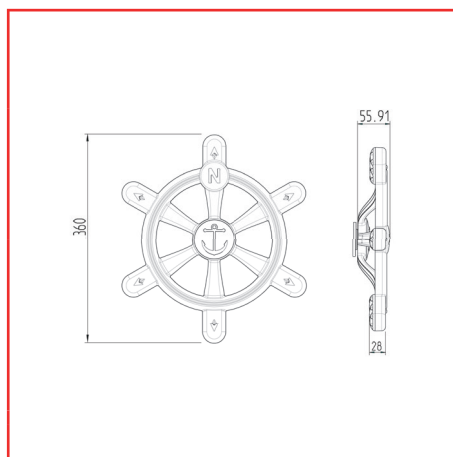
### DRAWINGS:



### VARIATIONS :

-  515.010.002.001 steering wheel 'diamond ship' - green
-  515.010.004.001 steering wheel 'diamond ship' - blue